

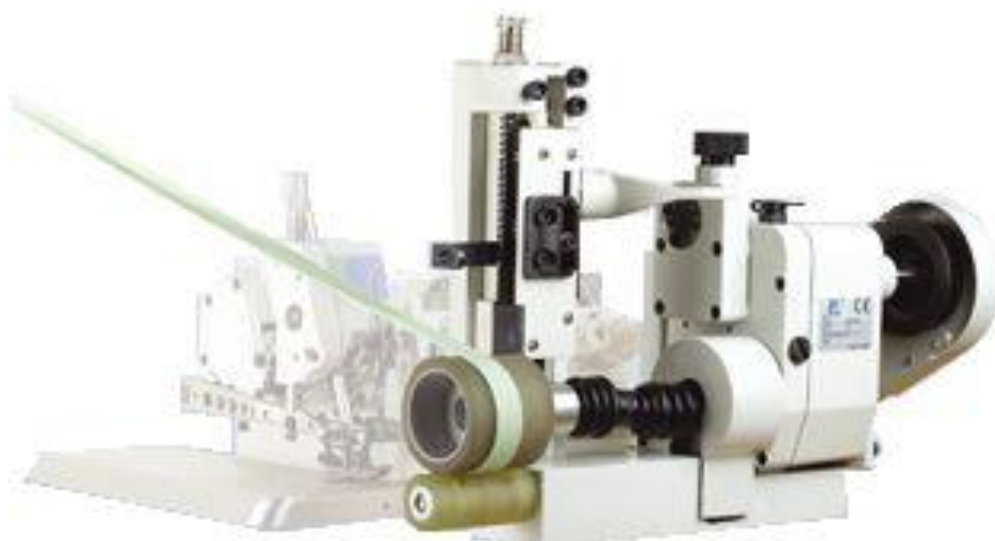

HPK-SP

前拉式(義大利麵專用)拖輪安裝手冊
THE INSTRUCTION GUIDE BOOK
FOR HPK-SP FRONT PULLER (Special
for spaghetti sewing)



安裝前,請詳細閱讀安裝說明書

PLEASE READ INSTRUCTIONS & ASSOCIATED DRAWINGS BEFORE INSTALLATION

HPK-SP

快速安裝指南 QUICK INSTALL GUIDE

皮帶輪螺栓
Studs for pulleys



支架固定
Install the lower plate

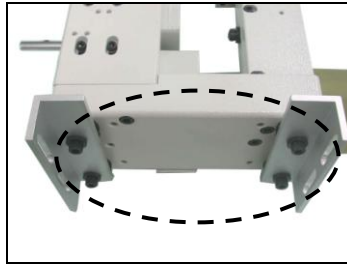
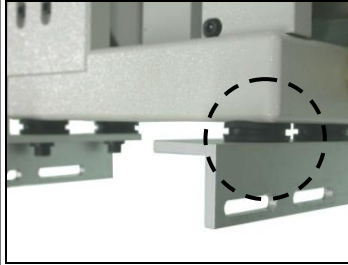

裝置機體
Main body assembly

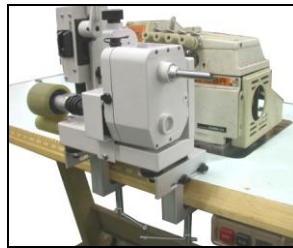
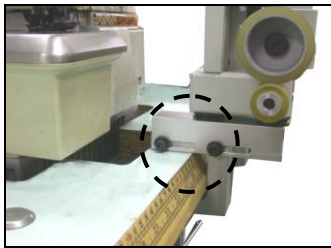
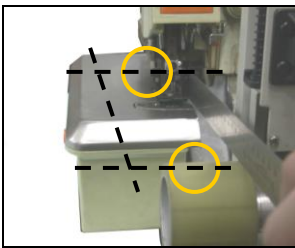

安裝皮帶
Install the belt

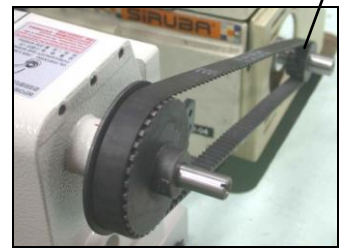
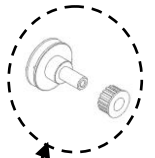

安裝皮帶蓋
Install the belt covering

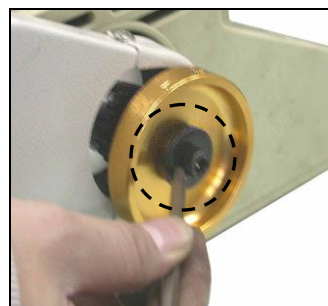
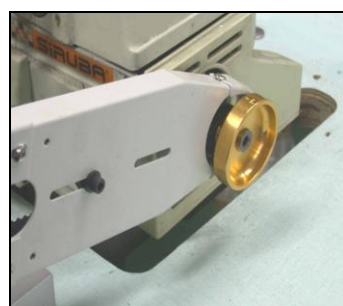
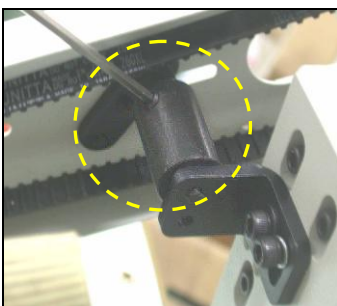
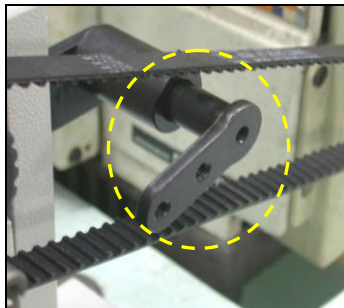
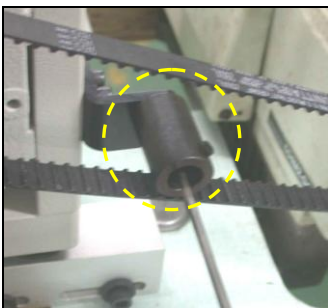

入力軸定位

Adjust input shaft position

一般針車定位時，
針車提升至最高點
General type, needle
to the toppest position

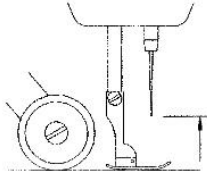

針送針車定位時，
針車下降至最低點
Needle feed type, needle
to the lowest position

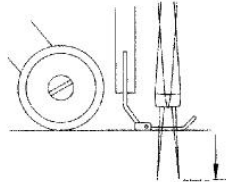

變速機的红線對齊入力軸紅線後，上緊時規齒輪螺絲
Meet the both red line on transmission input shaft,
tighten the timing gear screw

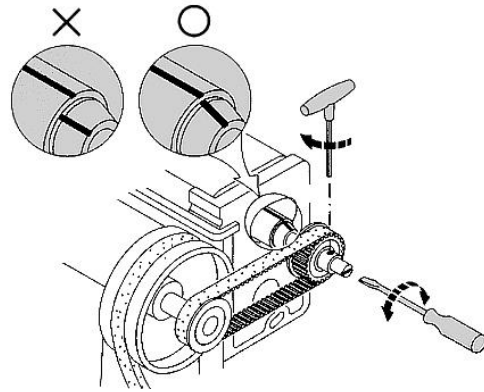

配合針車送料調整 Feeding adjustment

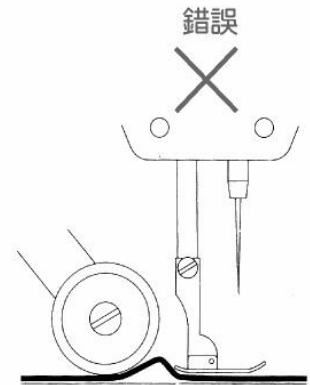
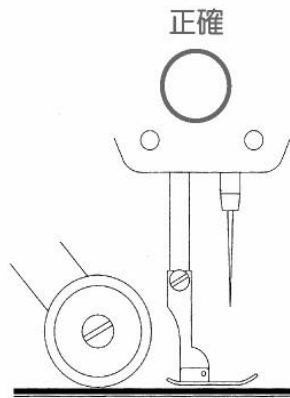
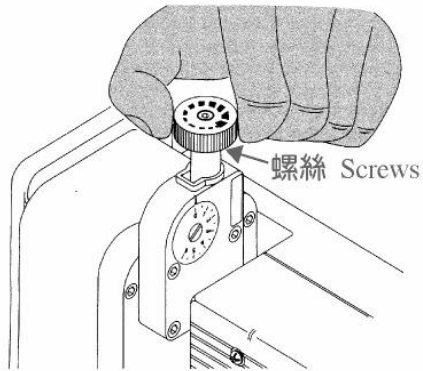

HPK-SP

